



**POWER GENERATION**



# OUR EXPERTISE

## ALTRONIC IGNITION

page 4



## HATRACO "PLUG & PLAY" IGNITION SYSTEMS

page 5



## HATRACO SPARK PLUG CABLES

page 7



## SPARK PLUGS

page 8



## HARNESSES & RETROFITS

page 10



## DETONATION DETECTION

page 11



## FUEL MANAGEMENT

page 12

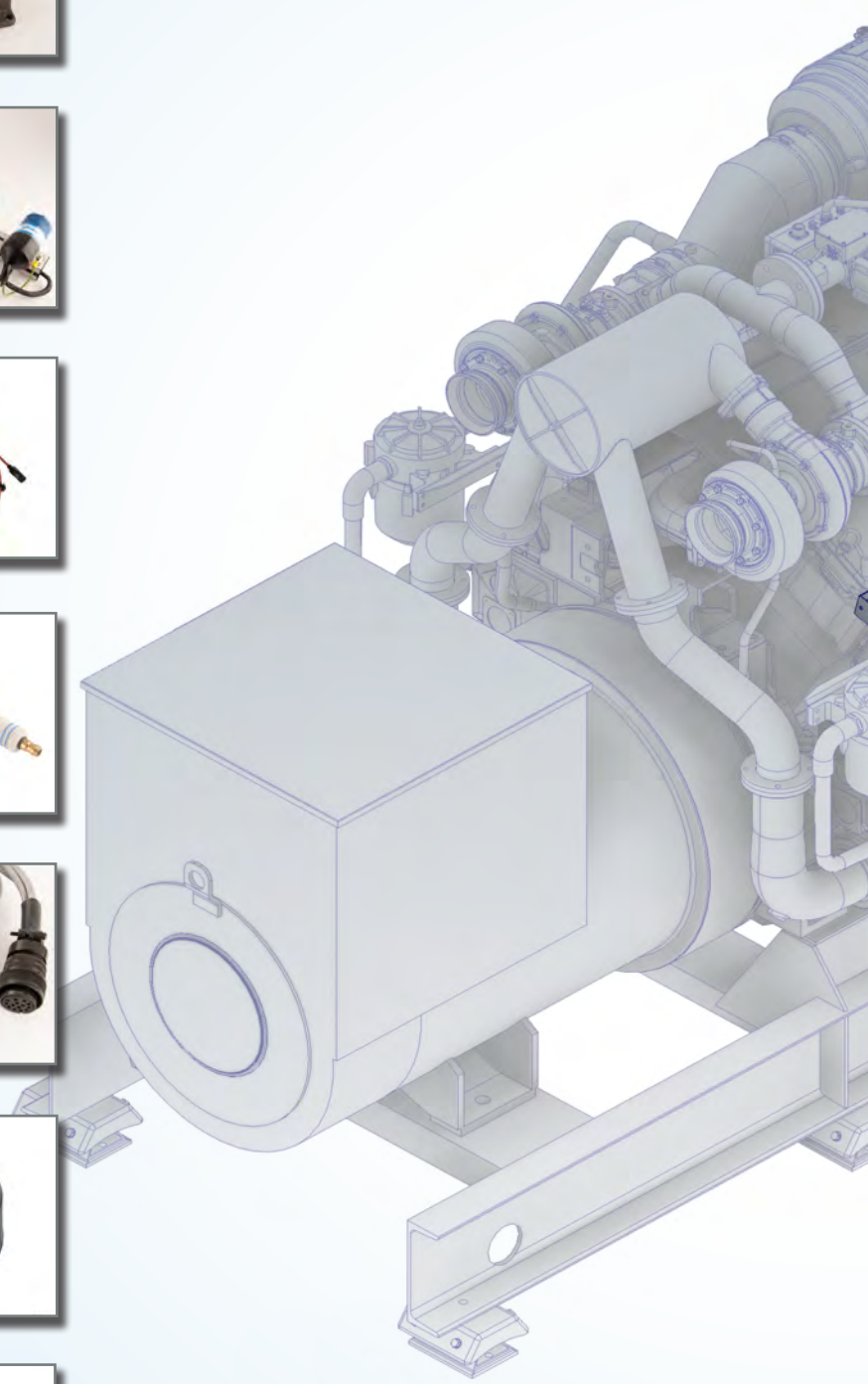



# INDEX /PROGRAM OVERVIEW

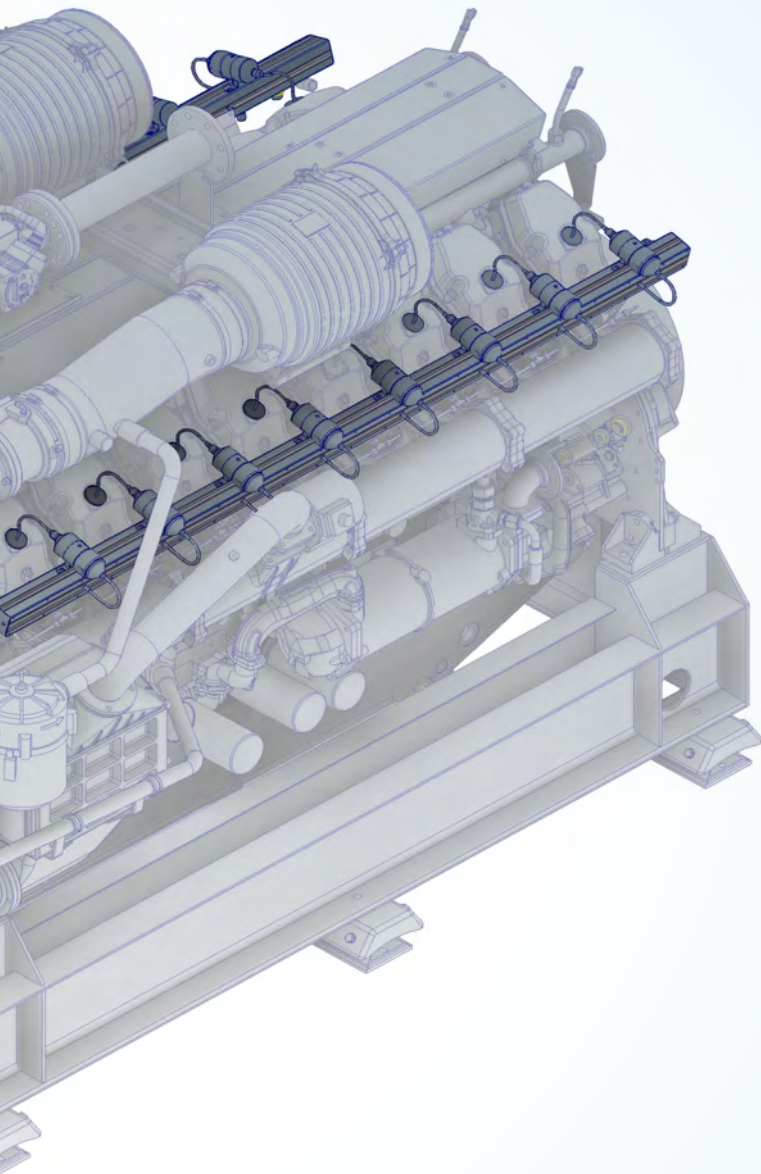

## CONTROLS

page 13



## STARTING SYSTEMS

page 14



## EMISSION

page 16



## FLUID CONTROL

page 18



## ON-SITE INSTALLATION

page 19



## SERVICE & INVENTORY

page 20



## ABOUT HATRACO

page 22

# IGNITION

## ALTRONIC IGNITION

DISN 800



CD 200EVS



CPU-2000



CPU-95EVS



CD-200D



## ALTRONIC IGNITION



Altronic has long been regarded as the world's leading manufacturer of ignition and control systems for original equipment as a standard for most major gas engine manufacturers, packagers and end users around the world. Small, large, natural, biogas or other alternative fuel fired engines, Hatraco offers you the perfect ignition system for it.

Main features:

- Up to 20 cylinders
- Capacitor-discharge high spark energy
- Up to 2500 us spark duration
- Mod bus, rs-485 communication
- Windows based terminal software
- Camshaft, ring gear triggered
- User programmable
- Comprehensive diagnostics.

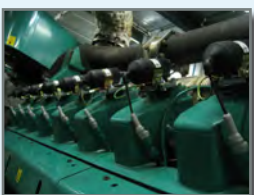

**altronic**  
HOERBIGER Engine Solutions

# IGNITION

## HATRACO PLUG AND PLAY IGNITION SYSTEM

CPU-95

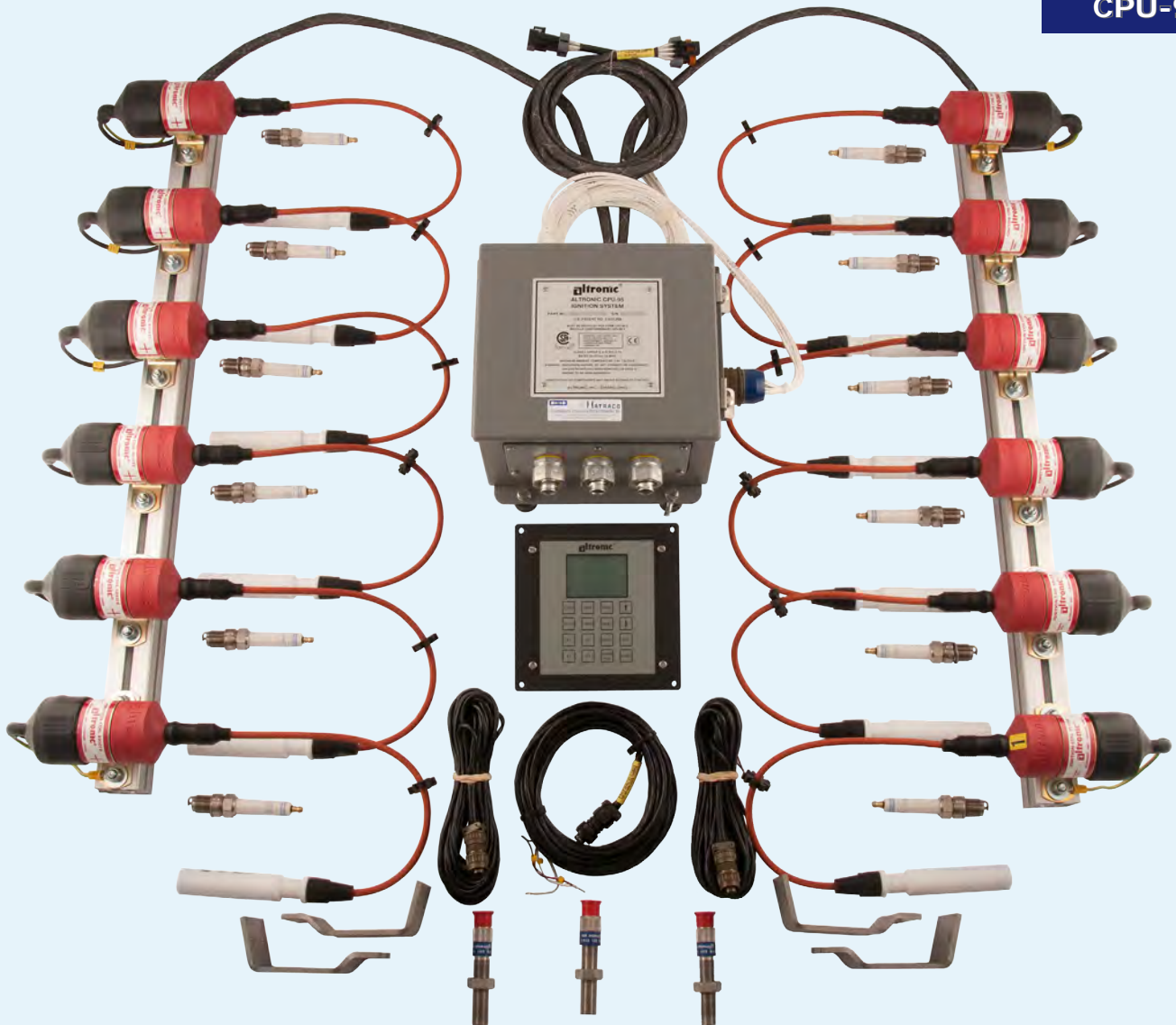

### “plug and play” IGNITION SYSTEM PACKAGES

Hatraco ignition rail systems are practically hand-made. Dedicated people are building the systems by hand and every wire and connection is carefully checked on quality and linkage. Finally all ignition rail systems are being tested in detail to make sure that all wires are properly connected, mounted in the correct order and can easily be installed as a “plug and play” system.





# IGNITION

## HATRACO IGNITION SYSTEM APPLICATION EXAMPLES

JENBACHER



LIEBHERR



MAN



DEUTZ

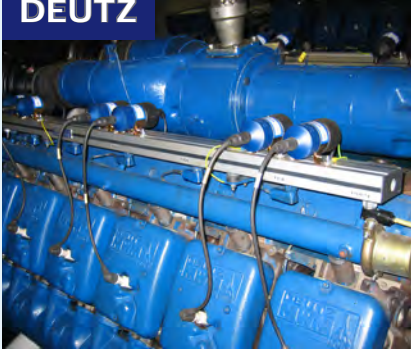

SCANIA



DAEWOO



LIEBHERR



GUASCOR



## IGNITION RAIL APPLICATIONS



Hatraco ignition systems are manufactured for nearly any engine brand and model, for in-line and V engines. There are standard ranges for various engines available. Besides the standard ranges Hatraco's ignition system can be custom made according to specific wishes and applications, also for small quantities.



# IGNITION

## HATRACO SPARK PLUG CABLES

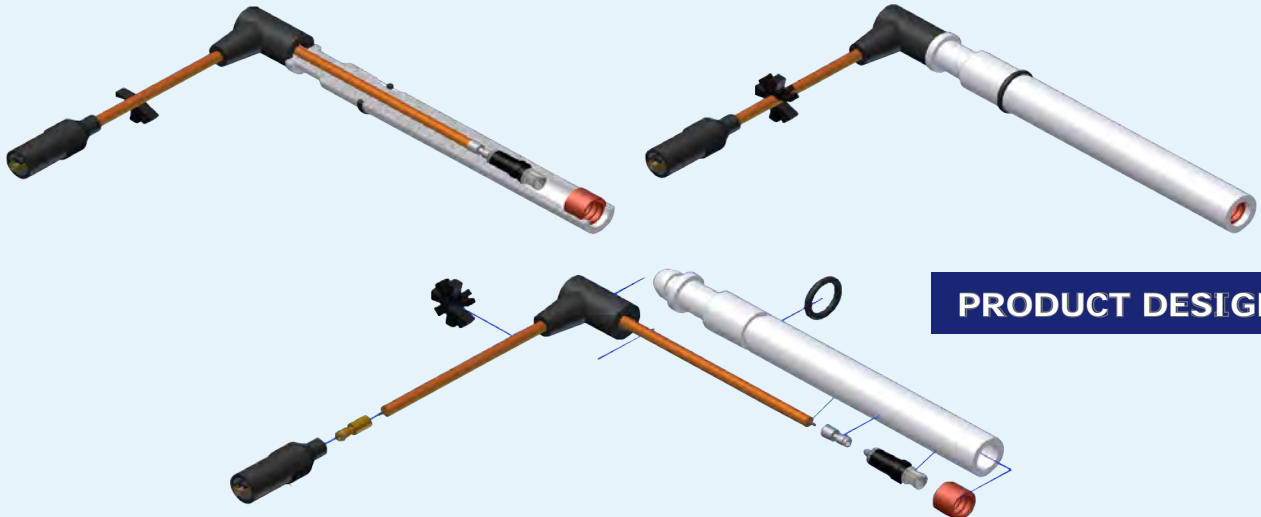

PRODUCT DESIGN

MANUFACTURING



## UNSHIELDED SPARK PLUG CABLES

Hatraco offers a large program of standard spark plug cables, based on a high quality PTFE (Teflon<sup>®</sup>) spark plug extension. In house production provides short lead times and a high grade of flexibility with respect to quantities, sizes, configurations and connector types. Extensions can be fitted with RFI reducing resistorized inserts. All extensions are being checked 100% on electrical conductivity and resistance value.



# IGNITION

## INDUSTRIAL SPARK PLUGS

**BOSCH**



*Hatraco is exclusive Bosch distributor for Europe and Russia.*

**DENSO**



**ALTRONIC**



**CHAMPION**



### SPARK PLUGS



**BOSCH**  
Invented for life

A new series of Bosch industrial spark plugs utilizes the latest spark plug technology to extend service life in the most demanding applications.

**DENSO**

With the IRIDIUM SAVER Denso developed a high performance, durable, high quality spark plug for gas engines.

**altronic**  
HOERBIGER Engine Solutions

FLASHGUARD® industrial spark plugs are designed to increase effective spark plug service life by reducing flashover and electrode erosion while optimizing combustion and minimizing radio frequency interference (RFI).



Champion Industrial Spark Plugs cover the widest range of possible applications.



# IGNITION

## INDUSTRIAL SPARK PLUGS & IGNITERS

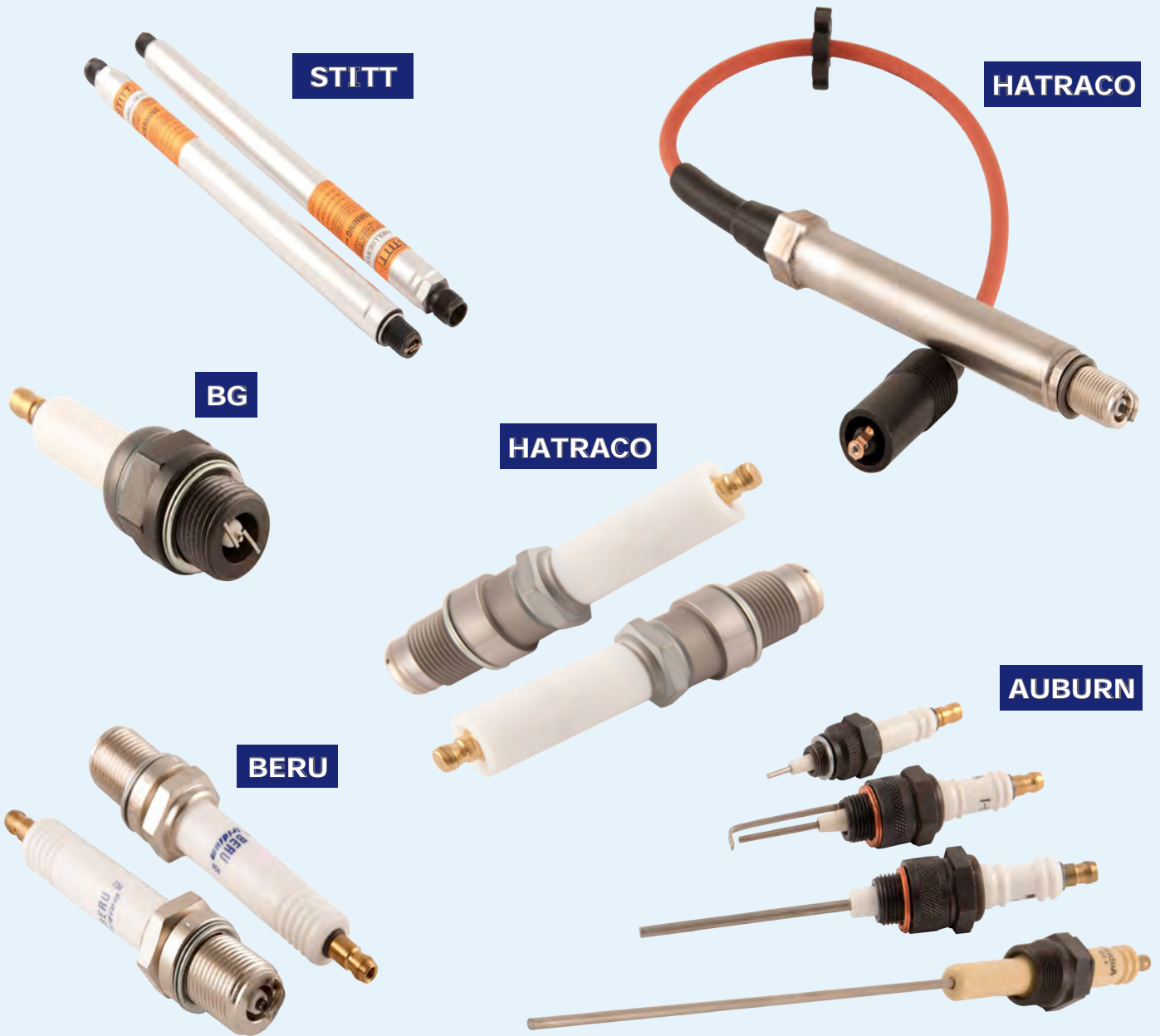

### SPARK PLUGS & IGNITERS



Stitt spark plugs for industrial gas engines in compressor and generator application.



Igniters & Flame Rods - Reliable performance in applications that demand nothing less



High-performance spark plugs for stationary gas-powered industrial engines.



BG manufactures high performance iridium electrode spark plugs for industrial engines.



Prechamber spark plugs - designed specifically for gas engines. Accessories/tools: Spark plug socket, sealing rings, spark plug cleaning, spark plug grease.



# IGNITION

## HARNESSES & RETROFITS

OUTPUT



INPUT



JENBACHER

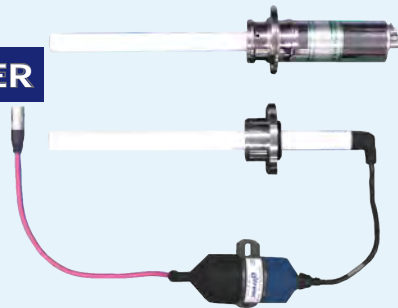

CUMMINS

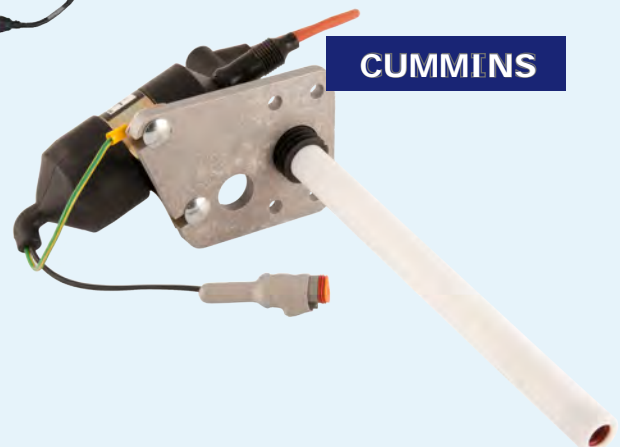

## HARNESSES

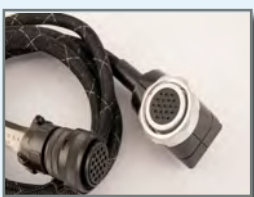

### Retrofit OEM solutions

The majority of the large industrial gas engines (>500kW) are standard equipped with OEM ignition systems. Many of these systems include engine specific coil rail- or coil-on-plug assemblies. Some of the OEM designs have proven to be unreliable and are typically expensive to replace. Hatraco has developed numerous solutions to retrofit these special set-ups into more simple and straight forward installations. We offer retrofits based on standard, well proven products such as Altronic ignition coils for Jenbacher 300 & 600 series, Cummins QSK, Deutz MWM TBG/TCG series and more.



# DETONATION DETECTION

DET 1600/1620 / sensors

## DET-1600

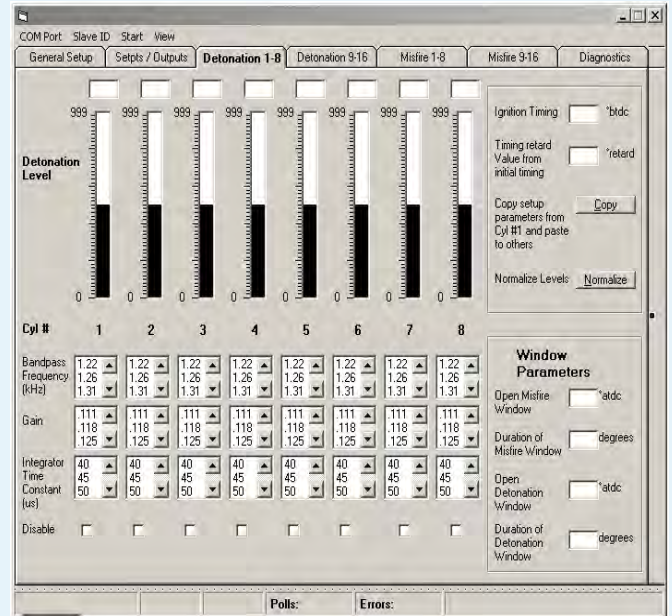

## DETONATION DETECTION

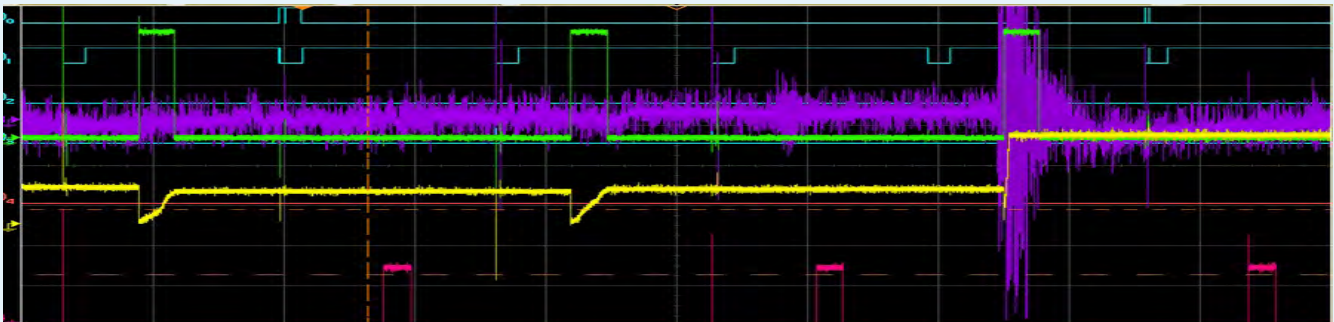

## DETONATION

Modern natural gas fueled engines in CHP applications are high efficiency engines with high BMEP. In order to minimize gas consumption and maximize the power output, these engines are designed to run close to the detonation limit. They are set up for operation on natural gas with a specific heating value and methane number.

Natural gas suppliers can supply different gas compositions with similar heating value's and different methane numbers. Safe operation is no longer ensured when the methane number of the gas is lower than what the engine is setup for.

Altronic has developed a detonation detection system that can be used to protect a gas engine against detonation damage. This DET-1600 is available for engines up to 16 cylinders. When detonation is detected, the DET-1600 can reduce engine load, retard ignition timing or shut down the engine.



# FUEL MANAGEMENT

AFR-CONTROL / CARBURATORS / FUEL SUBSTITUTION

## AFR-CONTROL



## SUBSTITUTION

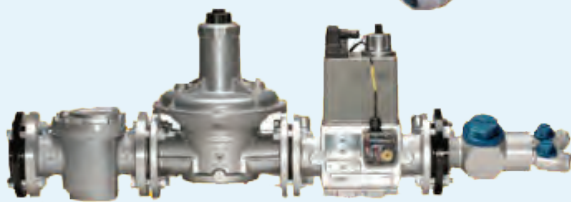

## CARBURATORS



## FUEL MANAGEMENT



### The GTI Bi-Fuel System from Altronic.

- Allow diesel engines to safely operate on gas percentages up to a maximum of 70% of the total fuel requirement.
- Save on operating fuel costs by using natural gas with return to 100% diesel operation at any time
- Allows the use of available or interruptible gas supplies
- No modification to internal engine components is required
- Cleaner burning natural gas reduces exhaust emissions
- Reduces requirements for on-site fuel storage
- Unique, patented design ensures no loss of power or efficiency.



# CONTROLS

GENERATOR / TEMPERATURE / PRESSURE / RPM

ANNUNCIATOR



IGNITION



GENERATOR



TEMPERATURE



PRESSURE



## CONTROLS

**Altronic** offers a wide range of digital instruments that can be mounted in panels by the **Altronic Controls** department. A complete line of digital monitoring devices is available for integration into Altronic annunciator systems, for stand-alone service, or for use in conjunction with other non-Altronic monitoring and control systems. A partial list includes single and multipoint digital temperature gauges and scanners, pyrometers, pressure gauges and monitors, tachometers, and over-speed, and hourmeter devices. Many of these products are suitable for use in environmentally harsh or hazardous areas.



# START SYSTEMS

TECH DEVELOPMENT INC.



T100-B



T100-V



T50

## TDI AIR STARTERS



**At Sea, Underground or on Rails, anything less than a TDI TURBOTWIN™ is a compromise.**

- Low pressure turbine starter
- More efficient than any other
- No need for messy lubricators > cleaner and less maintenance
- High quality technology based on aviation > reliable
- Fewer moving parts
- Unique open air path allows contaminants pass through
- Lightest in its class
- Greased for life
- Aerodynamic speed control
- Max torque at zero RPM
- Easy installation.





# START SYSTEMS

TECH DEVELOPMENT INC.

**45M**



**T25**



Vane-less design requires no lubrication of the drive air, eliminating oily, messy and hazardous emissions.

Aerodynamically self-limiting turbine rotors won't overspeed.

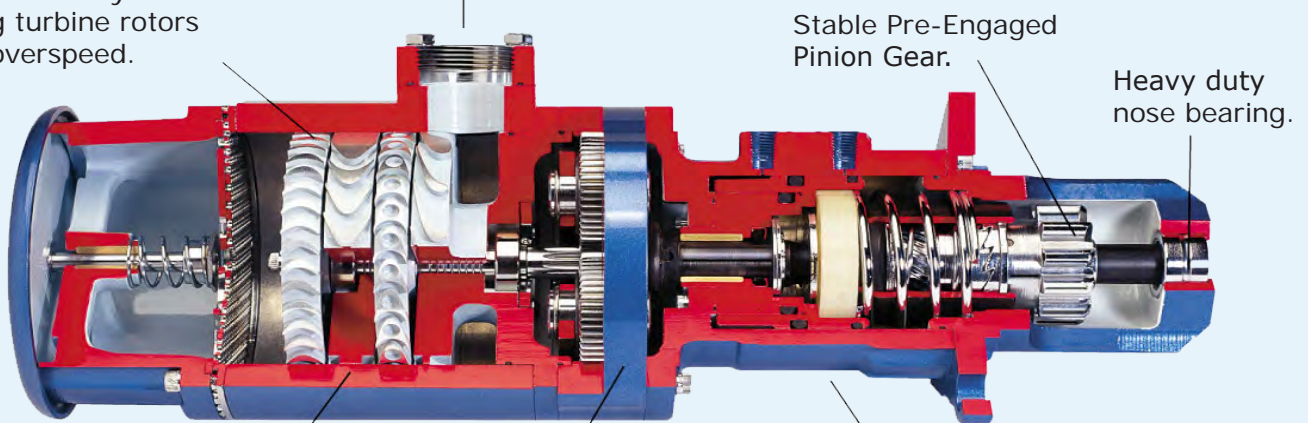

Stable Pre-Engaged Pinion Gear.

Heavy duty nose bearing.

Large open air passages resist erosion and tolerate contaminants that could destroy other starters.

A grease packed planetary gear set efficiently delivers the power and ensures maintenance-free operation

Indexing pre-engaged drive uses materials resistant to oils and fluids found in many wet sump applications.

## TDI AIR STARTERS

Engine range:		Suitable TDI:
up to 6	litre	: T20
up to 16	litre	: T25
up to 20	litre	: T30, 45M
20 to 70	litre	: T50
70 to 300	litre	: T100
> 300	litre	: Multiple T100's.



# START SYSTEMS

TECH DEVELOPMENT INC.



Starting air compressor and storage

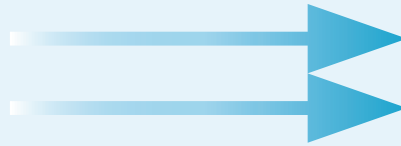

TDI TURBOFLOW Pressure Regulators

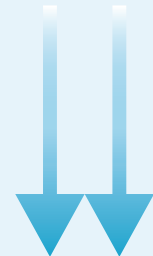

TDI TURBOTWIN Air Starters

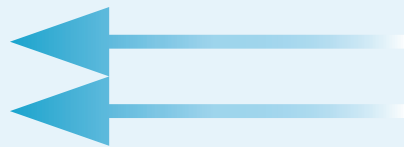

TDI TURBOVALVE Relay Valves

## Hatraco's air start package

### AIR START PACKAGE



#### Standard and custom air starting systems

Hatraco calculates, designs and provides complete standard and custom made air starting packages that provides sufficient capacity for the required cranking time to start one or more engines. Hatraco starting packages are fully adapted according to your application and include compressors, air receivers, pressure regulator, control panel and starters. All Hatraco air starting systems can be certified according to customer specifications and various industrial standards.

TECHNISCHE HANDELSONDERNEMING BY  
**HATRACO** 

**TDI**  
TECH DEVELOPMENT



# EMISSION

DCL INTERNATIONAL

SOOT FILTER



QUICK-LID



CATALYST

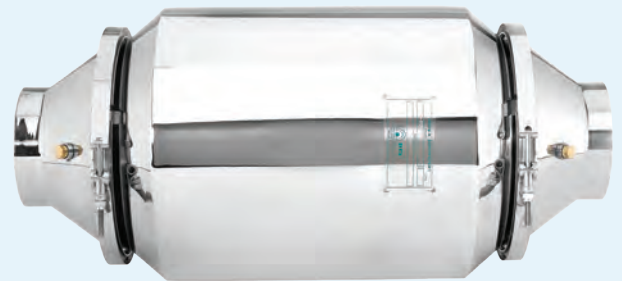

## SOOT & CATALYTIC CONVERTERS

**DCL International Inc.** is a leader in the design and manufacture of catalytic converters, catalytic mufflers, diesel particulate filters and stock mufflers for the air pollution control of off-highway vehicles, stationary engines, industrial processes and specialized on-highway vehicles. DCL supplies to world leading engine manufacturers, original equipment manufacturers and aftermarket retrofit.

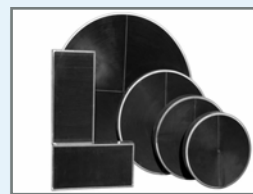

# FLUID CONTROL

KENCO

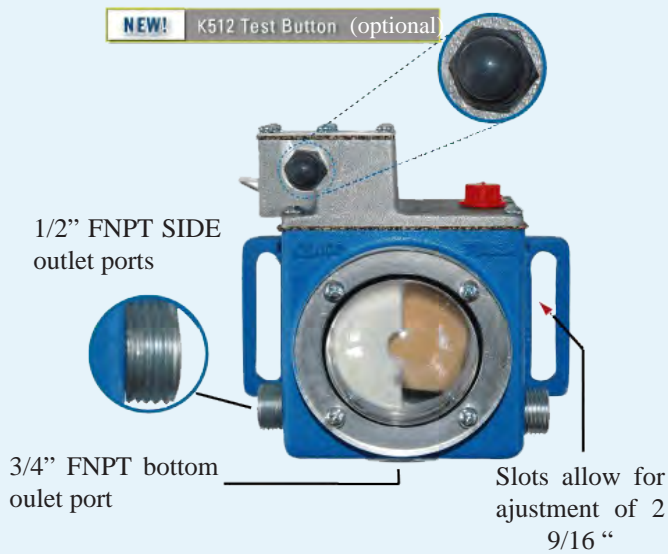

## OIL LEVEL CONTROLLERS & LEVEL GAUGES



**Electronic Level Measurement:** Advanced Electronic Instrumentation Solutions for Process Media Measurement.  
**Mechanical Level Measurement:** Versatile and Robust Mechanical Level Indication Solutions for Storage Tanks.  
**Sight Flow Indication:** Reliably and Efficiently Monitor Fluid Flow in Process Piping Systems.  
**Chemical Process Equipment:** Precise and Accurate Solutions for Monitoring the Performance of Chemical Injection Systems.  
**Engine & Gas Compressor Equipment:** Safety and Control Devices for Engine and Gas Compressor Applications.





# AFTER SALES

## ON-SITE INSTALLATION & TRAINING



## INSTALLATION & TRAINING

For major **Oil & Gas companies** throughout the whole of Europe, **Hatraco** has supplied many Sophisticated Fuel Control-, Ignition- and Starting systems. The same people that have sold the products will also be there to assist with installation and help out with configuration, programming and finally starting up the engines. **Training and instruction** can be given on-site at the engine or inhouse by means of demonstration devices that will show all features of the systems. All products will be supplied with required product certificates and installation drawings.







# COMPRESSOR MARKET



## WEAR CONTROL



## PRODUCT LINE

### Compression- & Hazardous environments

For applications in hazardous/explosion endangered environments special products are required.

Our **"compressor minded brochure"** provides an overview of the following products:

- Ignition systems built in ex-proof enclosures,
- shielded coils, cables and sparkplugs.
- Fuel control products
- Wear control products
- Engine start products
- and more...





# ABOUT US

## Activities

Hatraco is an independent trading company specialized in ignition, governing and control products for industrial (spark ignited) reciprocating engines. 25 Years experience has lead to a situation where Hatraco can be a good partner in the upgrade of any engine making use of the best products that the market offers in order to create a custom made solution for both end users as well as packagers or OEM's.



Company founder - Co Hasselaar

## History

Hatraco (Hasselaar Trading Company) was founded in 1984 by Co Hasselaar as a one-man trading company in Zevenaar, a small city on the eastern border of the Netherlands. He quit his job being a sales engineer and started off on his own trading business in products for industrial reciprocating engines.

In the following years, business grew and Hatraco became European distributor for Altronic Inc. The company built up a dealer network throughout Europe and through this network its main goals are to establish a solid and reliable European source for products of well known world wide manufacturers.

## Representation

Hatraco is authorized European distributor for  
**Altronic LLC** - Ignition and engine control products  
**Tech Development Inc.** - Engine air starters  
**Kenco Engineering Co. Inc.** - Level control products  
**The BG Service Co. Inc.** - Ignition accessories  
**Denso** - Industrial spark plugs  
**Bosch** - Industrial spark plugs  
**Stitt** - Industrial spark plugs  
**Champion** - Industrial spark plugs  
**DCL Inc.** - Catalytic converters, diesel particulate filters

## Manufacturing

### Spark plug leads

for the after market as well as for the OEM market.

### Pre-wired ignition systems

for a wide variety of engines, standard or shielded



Head Office in Duiven



Sales and Production facility in Duiven

## XATPAKO OOO

### Russia

In 2008, Hatraco BV established a daughter company (Hatraco OOO) in the South Moscow Region, from where we are covering Russia for all manufactures that are also represented by Hatraco BV in Europe.

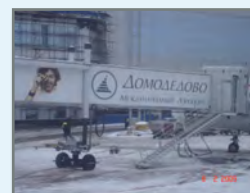
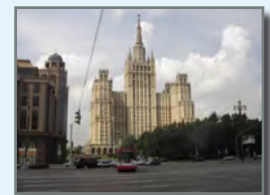

# REPRESENTATIVES

## Germany

BHKW Systeme Weigelt G.m.b.H.  
Service & Vertrieb  
Mr. Lutz Weigelt  
Bahnhofsplatz 2  
86459 Gessertshausen  
Tel : (+49) (0) 8238 964770  
Mobile : (+49) (0) 171 772 8584  
Fax : (+49) (0) 8238 9647746  
E-mail : info@bhkw-systeme-weigelt.de  
Internet: www.bhkw-systeme-weigelt.de

## United Kingdom

R & M Walsh Ltd.  
Mr. Richard Walsh  
22 Bridle Path.  
Ash Bank  
Stoke on Trent ST2 9EG  
Tel : (+44) 1782858769  
Fax : (+44) 1782858769  
E-mail : richard.rmwalshltd.co.uk  
Internet: www.rmwalshltd.co.uk

## Italy

Forté Engineering  
Forniture e Tecnologie per l'Energia  
Mr. Maurizio Zemiti  
Via Lombardia, 3  
26015 Soresina (CR)  
Tel : (+39) 374341399  
Mobile : (+39) 3358393336  
Fax : (+39) 347341399  
E-mail : info@forte-engineering.it  
Internet: www.forte-engineering.it

## Spain

Seyber Representaciones SL  
Mr. Enrique Bernardo  
Colada de Pozuelo 2B  
Polg. Ind. Ventorro el Cano  
(Antigua Ctra. Boadilla del Monte)  
28925 Alcorcon (Madrid)  
Tel : (+34) 916327153  
Fax : (+34) 916324028  
Mobile : (+34) 629305699  
E-mail : ebl@seyber.com  
Internet: www.seyber.com

## Hungary

Euroturbo Kft.  
mr. Zsolt Pál  
Cankó tér 8.  
1223. Budapest  
Tel : (+36) 14248365  
Fax : (+36) 14248366  
E-mail : sales@euroturbo.hu

## France

Seiser-pro.com  
Mr. Martin Seiser  
Z.A. Champs Casselin  
F-89000 ST. GEORGES/Baulche  
Tel : (+33) 386462881  
Cell : (+33) 688882332  
Fax : (+33) 386483958  
E-mail : seiser@seiser-pro.com  
Internet: www.seiser-pro.com

## Estonia, Latvia, Lithuania

sia I-con  
Mr Edzus Kašs  
Ausekja 3-63  
LV-1010 Riga, Latvia  
Tel : (+371) 26176130  
E-mail : sales@icon.lv  
Internet: www.seyber.com

## Romania

IR cat-co s.r.l.  
Mr. M. Nestor  
Sos. București, nr. 10  
077055, Ciorogârla  
Bucharest  
Tel : (+40) 021 317 0190  
Fax : (+40) 021 317 0196  
E-mail : office @ircat.ro  
Internet: www.ircat.ro



# BUSINESS PARTNERS

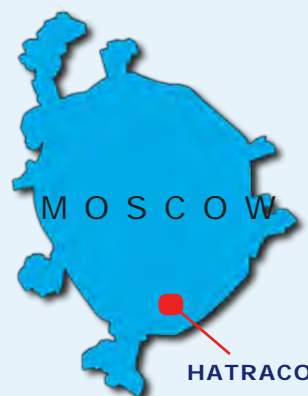

## CONTACT

### Hatraco Technische Handelsonderneming B.V.

Van't Holland 24-B 6921 GW Duiven The Netherlands

Phone: +31 316 280191 Fax: +31 316 281161

E-mail: [sales@hatraco.com](mailto:sales@hatraco.com)

Internet: [www.hatraco.com](http://www.hatraco.com)

### Hatraco O.O.O.

Shkol'naya Ulitsa 84A -Suite 200

142703 Vidnoe Moscow Region Russian Federation

Phone: +7 495 2236144 Fax: +7 495 6400195

E-mail: [sales@hatraco.ru](mailto:sales@hatraco.ru)

Internet: [www.hatraco.ru](http://www.hatraco.ru)